



High-Performance Transformerless On-Line UPS

**EAST UPS
Guard
Power Well**



EAST GROUP CO., LTD.

No.6 Northern Industry Road, Songshan Lake Sci.&Tech.
Industrial Park, Dongguan City, Guangdong, China (523808)
Tel: +86 769 22898801
Fax: +86 769 87920552
Email: eastups@eastups.com
<http://www.eastups.com>



EAST GROUP CO., LTD.
<http://www.eastups.com>



COMPANY PROFILE

About Us

EAST Group Co., Ltd. established in 1989, is a global digital industry and smart energy integrated solution supplier and excellent listed company (stock code 300376), having registered capital of 2.3 billion CNY and a headquarter with 200,000m² manufacturing and R&D space in Dongguan city. We keep growing our marketing and service network covering more than 140 countries' partners and customers. We have been awarded Global Top 500 New Energy Enterprises, and the 117th China Patent Excellence Award with more than 800 patents.

Our Products

EAST is ISO 9001: 2015 and ISO 14001: 2015 certified, and committed to providing green, energy-saving, stable, reliable and continuous power supply products and solutions. Our main products and services include:

- 1) UPS & Data center solutions
- 2) Solar inverters & PV energy solutions
- 3) Electric vehicle charging station
- 4) Energy storage & Smart micro-grid system
- 5) Stabilizer (AVR)
- 6) EPS (Emergency power supply)
- 7) Lead-acid maintenance-free battery

Our Team

EAST R&D team consists of 600 professional engineers and power experts. A Postdoctoral Scientific Research Workstation granted by the National Ministry of Personnel, and four R&D and operation bases in Dongguan, Chengdu, Nanjing, Xi'an city have been established, which constantly bring in talent from all over the world to join us.

Our Mission

Customer satisfaction is our permanent pursuit. To consistently create maximum value for customers, we focus on our customers' market challenges and needs by providing excellent power supply solutions and high quality products as well as the best service, and giving top priority to meeting customer requirements to enhance their competitiveness and profitability.

CONTENTS

- 01 EA900Pro
1 kVA ~ 3 kVA
- 03 EA900Pro RT
1 kVA ~ 3 kVA
- 05 EA900 G4
1 kVA ~ 3 kVA
- 07 EA900 G4
6 kVA ~ 10 kVA
- 09 EA900 RT G4
6 kVA ~ 10 kVA
- 11 EA900 G4
10 kVA ~ 20 kVA (3:1 / 1:1)
- 13 EA900 RT G4
10 kVA ~ 20 kVA (3:1 / 1:1)
- 15 EA990 G5
10 kVA ~ 60 kVA (3:3)
- 17 EA990 G5
80 kVA ~ 200 kVA (3:3)
- 19 EA990RT G5
10 kVA ~ 60 kVA (3:3)
- 21 EA990 G4
40 kVA ~ 200 kVA (3:3)

EA900Pro

1 kVA ~ 3 kVA
PF 0.9



Features

- High frequency on-line double conversion technology
- DSP (Digital signal processing) control technology
- Active power factor correction (APFC), input power factor up to 0.99
- Output power factor 0.9
- Wide input voltage range (110 V ~ 300 Vac) and frequency range (40 ~ 70 Hz)
- Auto sensing frequency
- 50 / 60 Hz frequency conversion
- Cold start
- Rear ventilation design and variable speed fan
- Effective software and hardware protection
- Quick and stable charging, 90% capacity restored in 4h (standard model UPS)
- Linear derating in low voltage input reducing battery discharging times
- Settable delayed start when power is restored
- Advanced battery management (ABM)
- Multiple functions settable via LCD: output voltage, EOD, auto-start, bypass mode, ECO mode and frequency conversion mode
- Multi-platform communications: RS232 (standard), USB / RS485 / SNMP / dry contacts (optional)
- Optional USB, RS485 card, AS400 dry contacts, SNMP card, SMS alarms, EPO function, and 12 A charger (2/3 kVA only)

Rear Panel

1. AC input socket
2. Battery connector (Optional)
3. Fan
4. USB (Optional)
5. EPO (Optional)
6. RS232
7. Intelligent slot (Optional)
8. Output sockets

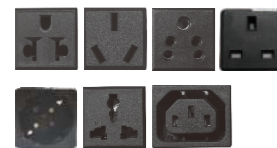

Optional outlets

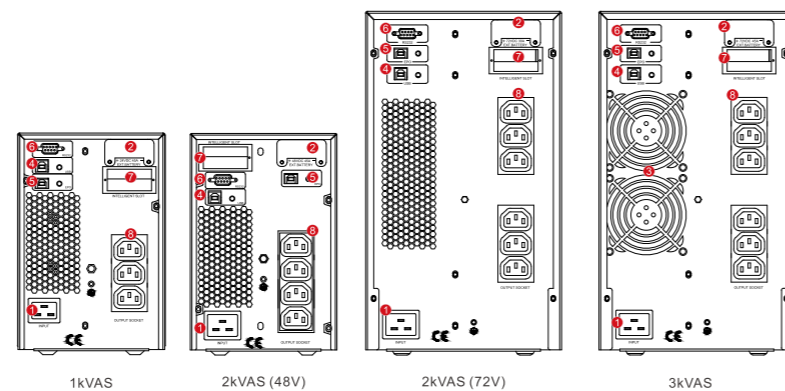

1kVAS

2kVAS (48V)

2kVAS (72V)

3kVAS

Specifications

MODEL	EA901P	EA902P	EA903P							
Capacity	1 kVA / 900 W	2 kVA / 1800 W	3 kVA / 2700 W							
INPUT										
Rated voltage	208 / 220 / 230 / 240 Vac									
Voltage range	110 ~ 176 Vac (linear derating between 50% and 100% load); 176 ~ 280 Vac (no derating); 280 ~ 300 Vac (derating 50%)									
Frequency	40 ~ 70 Hz (auto-sensing)									
Power factor	≥ 0.99									
Bypass voltage range	- 25% ~ +15% (settable)									
Total harmonic distortion (THDi)	≤ 6%									
OUTPUT										
Voltage	208 / 220 / 230 / 240 Vac (settable via LCD)									
Voltage regulation	±1%									
Frequency	45 ~ 55 Hz or 55 ~ 65 Hz (synchronized range); 50 / 60 Hz ± 0.1 Hz (battery mode)									
Waveform	Sinusoidal									
Power factor	0.9									
Total harmonic distortion (THDv)	≤ 2% (linear load), ≤ 5% (non-linear load)									
Crest factor	3:1									
Overload	105% ~ 125% for 1 min, 125% ~ 150% for 30 s, > 150% for 300 ms									
BATTERIES										
DC voltage	24 V (S)	36 V (S)	36 V (H)	48 V (S)	72 V (S)	72 V (H)	72 V (S)	96 V (S)	96 V (H)	
Inbuilt battery	2×9 Ah	3×7 Ah	/	4×9 Ah	6×7 Ah	/	6×9 Ah	8×7 Ah	/	
Charging current (max.)	1 A		6 A		1 A		6 A		1 A	
Recharge time	Standard model: 90% capacity restored in 3 hours; Long time model: depend on the capacity of battery									
SYSTEM										
Efficiency	≥ 90% (Mains mode)		≥ 91% (Mains mode)		≥ 92% (Mains mode)					
	≥ 85% (Battery mode)		≥ 86% (Battery mode)		≥ 87% (Battery mode)					
	≥ 95% (ECO mode)		≥ 96% (ECO mode)		≥ 97% (ECO mode)					
Transfer time	Mains mode to battery mode: 0 ms Inverter mode to bypass mode: 4 ms (typical)									
Protections	Short-circuit, overload, overtemperature, battery discharge protection and fan testing protection									
Communications	RS232 (standard), USB / RS485 / dry contacts / SNMP (optional)									
Display	LCD + LED									
Standards	EN 62040-1, EN 62040-2, EN 61000-3-2, EN 61000-3-3, IEC 61000-4-2, IEC 61000-4-3, IEC 61000-4-4, IEC 61000-4-5, IEC 61000-4-6, IEC 61000-4-8, IEC 61000-4-11, IEC 61000-2-2, IEC 62040-2, IEC 62040-1, IEC 62040-3									
OTHERS										
Operating temperature	0°C ~ 40°C									
Storage temperature	-25°C ~ 55°C (without batteries)									
Relative humidity	0 ~ 95% (non-condensing)									
Altitude	≤ 1000 m, derating 1% for each additional 100 m									
IP rating	IP 20									
Noise level at 1m	≤ 50 dB									
Dimensions (W×D×H) (mm)	144 x 312 x 216	144 x 317 x 216	144 x 336 x 216	144 x 417 x 216	191 x 419 x 335	191 x 418 x 335	191 x 419 x 335		191 x 418 x 335	
Packaged dimensions (W×D×H) (mm)	230 x 402 x 315	230 x 460 x 315	232 x 417 x 318	230 x 506 x 315	277 x 500 x 435	318 x 533 x 471	277 x 500 x 435		277 x 500 x 435	
Net weight (kg)	11	12.8	6	16.4	23.1	10.5	24.3	29.4	11	
Gross weight (kg)	11.3	14	7	17.8	24.7	12	25.9	31.1	12.5	

- Derate capacity to 70% in CUCF mode and to 90% when the output voltage is adjusted to 208 Vac.
- S means standard model, H means long time model.
- All specifications are subject to change without notice.
- Custom-made specifications are acceptable.

EA900Pro RT

1 kVA ~ 3 kVA
PF 0.9



Features

- High frequency on-line double conversion technology
- DSP (Digital signal processing) control technology
- Active power factor correction (APFC), input power factor up to 0.99
- Output power factor 0.9
- Wide input voltage range (110 V ~ 300 Vac) and frequency range (40 ~ 70 Hz)
- Auto sensing frequency
- 50 / 60 Hz frequency conversion
- Cold start
- Rear ventilation design and variable speed fan
- Effective software and hardware protection
- Quick and stable charging, 90% capacity restored in 3h (standard model UPS)
- Linear derating in low voltage input reducing battery discharging times
- Settable delayed start when power is restored
- Hot-swappable battery
- Advanced battery management (ABM)
- Multiple functions settable via LCD: output voltage, EOD, auto-start, bypass mode, ECO mode and frequency conversion mode
- Multi-platform communications: RS232 (standard), USB / RS485 / SNMP / dry contacts (optional)
- Optional USB, RS485 card, AS400 dry contacts, SNMP card, SMS alarms, EPO function, MBS (External maintenance bypass switch)

Rear Panel

1. AC input socket
2. Battery connector (Optional)
3. Fan
4. USB (Optional)
5. EPO (Optional)
6. RS232
7. Intelligent slot (Optional)
8. Output sockets

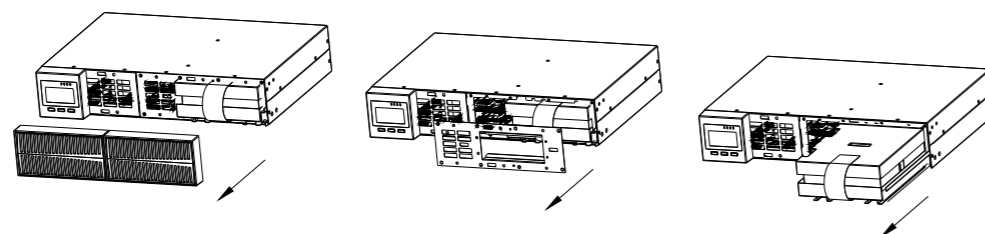
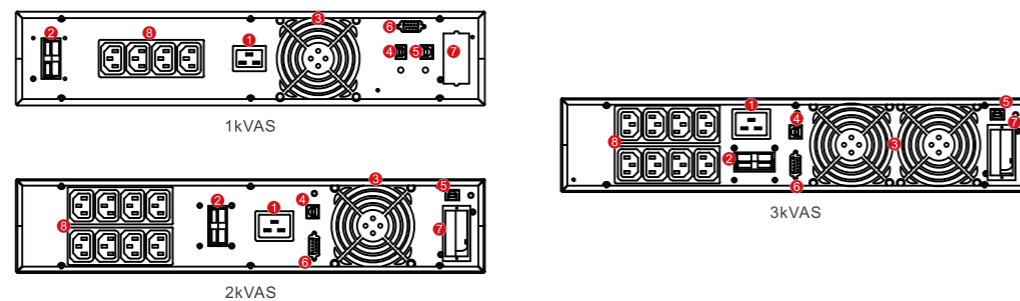

Easy for maintenance, hot-swappable battery

Specifications

MODEL	EA901PRT		EA902PRT		EA903PRT				
Capacity	1 kVA / 900 W		2 kVA / 1800 W		3 kVA / 2700 W				
INPUT									
Rated voltage	208 / 220 / 230 / 240 Vac								
Voltage range	110 ~ 176 Vac (linear derating between 50% and 100% load); 176 ~ 280 Vac (no derating); 280 ~ 300 Vac (derating 50%)								
Frequency	40 ~ 70 Hz (auto-sensing)								
Power factor	≥ 0.99								
Bypass voltage range	-25% ~ +15% (settable)								
Total harmonic distortion	≤ 6%								
OUTPUT									
Voltage	208 / 220 / 230 / 240 Vac (settable via LCD)								
Voltage regulation	± 1%								
Frequency	45 ~ 55 Hz or 55 ~ 65 Hz (synchronized range); 50 / 60 Hz ± 0.1 Hz (battery mode)								
Waveform	Sinusoidal								
Power factor	0.9								
Total harmonic distortion (THDv)	≤ 2% (linear load); ≤ 5% (non-linear load)								
Crest factor	3:1								
Overload	105% ~ 125% for 1 min, 125% ~ 150% for 30 s, > 150% for 300 ms								
BATTERIES									
DC voltage	24 V (S)	36 V (S)	36 V (H)	48V (S)	72 V (S)	72 V (H)	72 V (S)	96 V (S)	96 V (H)
Inbuilt battery	2×9 Ah	3×7Ah	/	4×9Ah	6×7Ah	/	6×9Ah	8×7Ah	/
Charging current (max.)	1 A		6 A	1 A		6 A	1 A		6 A
Recharger time	Standard model: 90% capacity restored in 3 hours; Long time model: depend on the capacity of battery								
SYSTEM									
Efficiency	≥ 90% (Mains mode)		≥ 91% (Mains mode)		≥ 92% (Mains mode)				
	≥ 85% (Battery mode)		≥ 86% (Battery mode)		≥ 87% (Battery mode)				
	≥ 95% (ECO mode)		≥ 96% (ECO mode)		≥ 97% (ECO mode)				
Transfer time	Mains mode to battery mode: 0 ms Inverter mode to bypass mode: 4 ms (typical)								
Protections	Short-circuit, overload, overtemperature, battery discharge protection and fan testing protection								
Communications	RS232 (standard), USB / RS485 / dry contacts / SNMP (optional)								
Display	LCD + LED								
Standards	EN 62040-1, EN 62040-2, EN 61000-3-2, EN 61000-3-3, IEC 61000-4-2, IEC 61000-4-3, IEC 61000-4-4, IEC 61000-4-5, IEC 61000-4-6, IEC 61000-4-8, IEC 61000-4-11, IEC 61000-2-2, IEC 62040-2, IEC 62040-1								
OTHERS									
Operating temperature	0°C ~ 40°C								
Storage temperature	-25°C ~ 55 °C (without batteries)								
Relative humidity	0~95% (non-condensing)								
Altitude	≤ 1000 m, derating 1% for each additional 100 m								
IP rating	IP 20								
Noise level at 1m	≤ 50 dB								
Dimensions (W × D × H) (mm)	440 x 338 x 88	440 x 430 x 88	440 x 468 x 88	440 x 430 x 88	440 x 560 x 88	440 x 468 x 88	440 x 560 x 88	440 x 468 x 88(UPS) 440 x 468 x 88(BAT)	440 x 468 x 88
Packaged dimensions (W×D×H) (mm)	545 x 428 x 194	545 x 560 x 201	545 x 592 x 201	545 x 560 x 201	545 x 690 x 201	545 x 592 x 201	545 x 690 x 201	592 x 545 x 198(UPS) 597 x 545 x 198(BAT)	545 x 592 x 201
Net weight(kg)	10.6	15.5	7.6	18.7	25.6	9.7	26.8	9.45(UPS) 27.2(BAT)	10.1
Gross weight(kg)	11.3	18.6	11.1	21.8	25.8	13.2	29.7	12.97(UPS) 30.2(BAT)	13.6

•Derate capacity to 70% in CUCF mode and to 90% when the output voltage is adjusted to 208 Vac.
•S means standard model, H means long time model.

•All specifications are subject to change without notice.
•Custom-made specifications are acceptable.

EA900 G4

1 kVA ~ 3 kVA
PF 1.0



Features

- High frequency on-line double conversion technology
- DSP (Digital signal processing) control technology
- Active power factor correction (APFC), input power factor up to 0.99
- Output power factor 1.0
- Wide input voltage range (110V ~ 300Vac)
- Auto sensing frequency
- 50 / 60 Hz frequency conversion
- Digitally controlled charger, charging voltage and current configured by demands
- High charging current available (Max. 12 A)
- Cold start
- Rear ventilation design and variable speed fan
- Effective software and hardware protection
- Quick and stable charging, 90% capacity restored in 3h (standard model UPS)
- Linear derating in low voltage input reducing battery discharging times
- Advanced battery management (ABM)
- Multiple functions settable via LCD: output voltage, EOD, auto-start, bypass mode, ECO mode
- Multi-platform communications: RS232 (standard), USB / RS485 / SNMP / dry contacts (optional)
- Optional USB, RS485 card, AS400 dry contacts, SNMP card, SMS alarms, EPO function

Rear Panel

1. AC input socket
2. Battery connector (Optional)
3. Fan
4. USB (Optional)
5. EPO (Optional)
6. RS232
7. Intelligent slot (Optional)
8. Output sockets

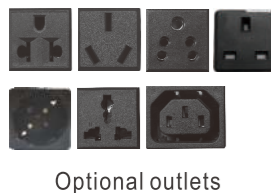
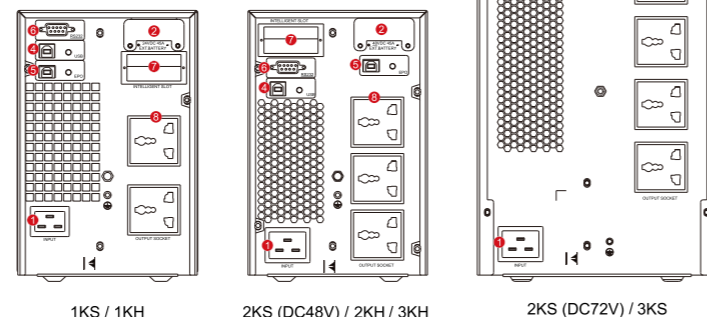

Optional outlets

Specifications

MODEL	EA901	EA902	EA903									
Capacity	1 kVA / 1 kW	2 kVA / 2 kW	3 kVA / 3 kW									
INPUT												
Rated voltage	208 / 220 / 230 / 240 Vac											
Voltage range	110 ~ 176 Vac (linear derating between 50% and 100% load); 176 ~ 280 Vac (no derating); 280 ~ 300 Vac (derating 50%)											
Frequency	50/60 Hz ± 5 Hz (auto-sensing)											
Power factor	≥ 0.99											
Bypass voltage range	- 40% ~ +20% (settable)											
Rated input frequency	50 Hz / 60 Hz (auto-sense)											
THDi	≤ 5%											
OUTPUT												
Voltage	208 / 220 / 230 / 240 Vac (settable via LCD)											
Voltage regulation	±1%											
Frequency	45 ~ 55 Hz or 55 ~ 65 Hz (synchronized range); 50 / 60 Hz ± 0.1 Hz (battery mode)											
Waveform	Sinusoidal											
Power factor	1.0											
THDv	≤ 2% (linear load), ≤ 5% (non-linear load)											
Crest factor	3:1											
Overload	105% ~ 110% for 30 min, 110% ~ 130% for 10 min, 130% ~ 150% for 30s, > 150% for 500 ms											
BATTERIES												
Battery type	Sealed lead acid maintenance free battery											
DC voltage	24V (S)	36V (S)	24V (H)	36V (H)	48V (S)	72V (S)	48V (H)	72V (H)	72V (S)	96V (S)	72V (H)	96V (H)
Inbuilt battery	2×9 Ah	3×7 Ah	/	/	4×9 Ah	6×7 Ah	/	/	6×9 Ah	8×7 Ah	/	/
Charging current (max.)	Standard model: 1 A, Long time model: 12 A (1 ~ 12A settable)											
Recharge time	Standard model: 90% capacity restored in 3 hours; Long time model: depend on the capacity of battery											
SYSTEM												
Efficiency	≥ 93.5% (Mains mode)		≥ 94.5% (Mains mode)		≥ 94.6% (Mains mode)							
	≥ 89.2% (Battery mode)		≥ 91% (Battery mode)		≥ 92.5% (Battery mode)							
	≥ 97.5% (ECO mode)		≥ 98.5% (ECO mode)		≥ 98.5% (ECO mode)							
Transfer time	Mains mode to battery mode: 0 ms			Inverter mode to bypass mode: 4 ms (typical)								
Protections	Short-circuit, overload, overtemperature, battery discharge protection and fan testing protection											
Communication port	RS232 (standard), USB / RS485 / SNMP/ dry contacts (optional)											
Display	LCD + LED											
ENVIRONMENT												
Operating humidity	0 ~ 95 % RH @ 0 ~ 40°C (non-condensing)											
Storage temperature	-25°C ~ 55°C (exclude batteries)											
Operating altitude	≤ 1000m, above 1000m, derating 1% for each additional 100 m											
IP rating	IP 20											
Noise level at 1m	≤ 50 dB		≤ 55dB									
OTHERS												
Dimensions (W×D×H) (mm)	144 ×312 ×216	144 ×371 ×216	144×312×216	144 ×417 ×216	191 ×419 ×335	144×417×216	191×419×335	144×417×216				
Packaged dimensions (W×D×H) (mm)	230 ×402 ×315	230 ×460 ×315	230×402×315	230 ×506 ×315	277 ×500 ×435	230×506×315	277×500×435	230×506×315				
Net weight (kg)	9.5	11.3	4.0	16.4	23.1	6.5	22.8	27.9	6.5			
Gross weight (kg)	10.5	12.3	5.1	17.9	24.6	8.0	24.3	29.4	8.0			

- Derate capacity to 90% when the output voltage is adjusted to 208Vac.
- S means standard model, H means long time model.
- All specifications are subject to change without notice.
- Custom-made specifications are acceptable.

EA900 G4

6 kVA ~ 10 kVA
PF 1.0



Features

- High frequency on-line double conversion technology
- Advanced DSP and 3-level technology
- Output power factor 1.0
- Active power factor correction (APFC), input power factor up to 0.99
- High efficiency 95% (up to 98% in ECO mode)
- Advanced digital parallel technology
- Wide input voltage range (110 ~ 288 Vac) and frequency range (40 ~ 70 Hz)
- 50 / 60 Hz frequency auto sensing
- Two modes of frequency conversion: 50 Hz input / 60 Hz output or 60 Hz input / 50 Hz output
- Dual-input design, supporting independent bypass
- Flexible battery configuration (settable 16 - 20 pcs batteries)
- Digitally controlled charger
- High charging current available (Max. 12 A)
- Charging voltage and current configured by demands
- Linear derating in low voltage input reducing battery discharging times, extending the service life of battery
- Intelligent battery management, automatic floating / equalizing charge control, charger dormancy control, increasing battery life by 50%

- Ability to switch on the UPS with batteries
- Settable delayed start time when mains power is restored, reducing the impact on power grid or generator
- Fan speed varies intelligently with temperature, reducing noise and extending its service life
- Equipped with self-aging function
- Compact internal layout, miniaturized the complete unit for small footprint
- LCD+LED display, multi-functional keys operation, friendly human-machine interface
- Powerful background software for parameters configuration
- Advanced multi-platform communications: RS232, USB, RS485, SNMP and dry contacts communication interfaces
- Effective software and hardware protection function, robust self-diagnostic function, and abundant event logs for check

Available Options

- RS232 and smart card slot included
- Optional parallel function, battery temperature compensation, SNMP card, USB, RS485 card, dry contacts, EMD, and SMS alarms

Rear Panel

1. RS232
2. EPO
3. Parallel Port (optional)
4. USB (optional)
5. Temperature Detection (optional)
6. Intelligent Slot
7. Reserved: for manual bypass or battery breaker or outlets etc.
8. Fans
9. Bypass Breaker
10. Input Breaker
11. GND
12. Terminals and Cover

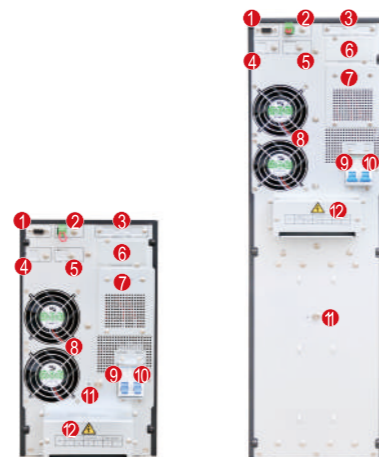

6/10 kVA (H)

6/10 kVA (S)

Specifications

MODEL	EA906	EA9010
Capacity	6 kVA / 6 kW	10 kVA / 10 kW
INPUT		
Input wiring	Single-phase three-wire (1Φ + N + PE)	
Rated voltage	208 / 220 / 230 / 240 Vac	
Voltage range	110 ~ 176 Vac (linear derating between 50% and 100% load); 176 ~ 288 Vac (no derating)	
Rated frequency	50 / 60 Hz (auto-sensing)	
Frequency range	40 ~ 70 Hz	
Power factor	≥ 0.99	
Bypass voltage range	- 40% ~ +15% (settable)	
Total harmonic distortion (THDi)	≤ 5%	
OUTPUT		
Output wiring	Single-phase three-wire (1Φ + N + PE)	
Rated voltage	208 (PF=0.9) / 220 / 230 / 240 Vac	
Voltage regulation	± 1%	
Frequency	Synchronized to bypass in mains mode; 50 / 60 Hz ± 0.1 Hz in battery mode	
Waveform	Sinusoidal	
Power factor	1	
Total harmonic distortion (THDv)	≤ 1% (linear load); ≤ 4% (non-linear load)	
Crest factor	3:1	
Overload	105% ~ 110% for 10 min, 110% ~ 125% for 1 min, 126% ~ 150% for 30 s	
BATTERIES		
DC voltage	192 Vdc (192 ~ 240 Vdc settable)	
Number of battery	16 pcs (16 ~ 20 settable)	
Inbuilt battery (standard model)	12 V / 7 Ah × 16	12 V / 9 Ah × 16
Charging current	Standard model: 1 A; Long time model: 5 A (default), 1 ~ 5 A settable, 12 A (optional)	
Recharge time	Standard model: 90% capacity restored in 8 hours; Long time model: depend on the capacity of battery	
SYSTEM		
Efficiency	≥ 94% at 100% load, max. 95% at 60% load, ≥ 98% in ECO mode	
Transfer time	0 ms	
Protections	Short-circuit, overload, overtemperature, battery low voltage, overvoltage, undervoltage and fan failure	
Max. number of parallel connections	4	
Communications	RS232 (standard), USB / RS485 / dry contacts / SNMP / battery temperature compensation (optional)	
Display	LCD + LED	
OTHERS		
Operating temperature	0°C ~ 40°C	
Storage temperature	-25°C ~ 55°C (without battery)	
Relative humidity	0 ~ 95% (non-condensing)	
Altitude	≤ 1000 m, derating 1% for each additional 100 m	
IP rating	IP 20	
Noise level at 1 m	≤ 55 dB	≤ 58 dB
Dimensions (W × D × H) (mm)	191 × 465 × 711 (S), 191 × 465 × 350 (H)	191 × 495 × 711 (S), 191 × 495 × 350 (H)
Packaged dimensions (W × D × H) (mm)	310 × 654 × 941 (S), 318 × 595 × 475 (H)	310 × 685 × 941 (S), 318 × 617 × 475 (H)
Net weight (kg)	53 (S), 14.5 (H)	62 (S), 16.5 (H)
Gross weight (kg)	61 (S), 16 (H)	70 (S), 18 (H)

- S means standard model; H means long time model.
- All specifications are subject to change without notice.

EA900RT G4

6 kVA ~ 10 kVA
PF 1.0



Features

- High frequency on-line double conversion technology
- Advanced DSP and 3-level technology
- Output power factor 1.0
- Active power factor correction (APFC), input power factor up to 0.99
- High efficiency 95% (up to 98% in ECO mode)
- Advanced digital parallel technology
- Wide input voltage range (110 ~ 288 Vac) and frequency range (40 ~ 70 Hz)
- 50 / 60 Hz frequency auto sensing
- Two modes of frequency conversion: 50 Hz input / 60 Hz output or 60 Hz input / 50 Hz output
- Hot-swappable battery
- Flexible battery configuration (settable 16 - 20 pcs batteries)
- Digitally controlled charger
- High charging current available (Max. 12 A)
- Charging voltage and current configured by demands
- Linear derating in low voltage input reducing battery discharging times, extending the service life of battery
- Intelligent battery management, automatic floating / equalizing charge control, charger dormancy control, increasing battery life by 50%

- Ability to switch on the UPS with batteries
- Settable delayed start time when mains power is restored, reducing the impact on power grid or generator
- Fan speed varies intelligently with temperature, reducing noise and extending its service life
- Equipped with self-aging function
- Compact internal layout, miniaturized the complete unit for small footprint
- LCD+LED display, multi-functional keys operation, friendly human-machine interface
- Powerful background software for parameters configuration
- Advanced multi-platform communications: RS232, USB, RS485, SNMP and dry contacts communication interfaces
- Effective software and hardware protection function, robust self-diagnostic function, and abundant event logs for check

Available Options

- RS232 and smart card slot included
- Optional parallel function, battery temperature compensation, SNMP card, USB, RS485 card, dry contacts, EMD, and SMS alarms

Rear Panel

1. SNMP (optional)
2. Fans
3. Parallel (optional)
4. RS232
5. EPO
6. USB (optional)
7. Temperature Compensation (optional)
8. GND
9. Bypass Breaker
10. Terminal and Cover
11. Battery Pack



Display panel can be rotated

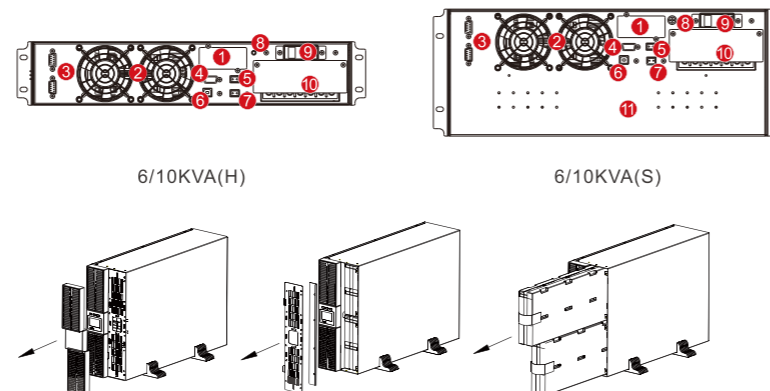

6/10KVA(H)

6/10KVA(S)

Easy for maintenance, hot-swappable battery

Specifications

MODEL	EA906RT	EA9010RT
Capacity	6 kVA / 6 kW	10 kVA / 10 kW
INPUT		
Input wiring	Single-phase three-wire (1Φ + N + PE)	
Rated voltage	208 / 220 / 230 / 240 Vac	
Voltage range	110 ~ 176 Vac (linear derating between 50% and 100% load); 176 ~ 288 Vac (no derating)	
Rated frequency	50 / 60 Hz (auto-sensing)	
Frequency range	40 ~ 70 Hz	
Power factor	≥ 0.99	
Bypass voltage range	- 40% ~ +15% (settable)	
Total harmonic distortion (THDi)	≤ 5%	
OUTPUT		
Output wiring	Single-phase (L-N)	
Rated voltage	208 (PF=0.9) / 220 / 230 / 240 Vac	
Voltage regulation	± 1%	
Frequency	Synchronized to bypass in mains mode; 50 / 60 Hz ± 0.1 Hz in battery mode	
Waveform	Sinusoidal	
Power factor	1	
Total harmonic distortion (THDv)	≤ 1% (linear load); ≤ 4% (non-linear load)	
Crest factor	3:1	
Overload	105% ~ 110% for 10 min, 110% ~ 125% for 1 min, 126% ~ 150% for 30 s	
BATTERIES		
DC voltage	192 Vdc (192~240 Vdc settable)	
Number of battery	16 pcs (16 ~ 20 settable)	
Inbuilt battery (standard model)	12 V / 7 Ah × 16	12 V / 9 Ah × 16
Charging current	Standard model: 1 A; Long time model: 5 A (default), 1 ~ 5 A settable, 12 A (optional)	
Recharge time	Standard model: 90% capacity restored in 8 hours; Long time model: depend on the capacity of battery	
SYSTEM		
Efficiency	≥ 94% at 100% load, max. 94.5% at 60% load, ≥ 98% in ECO mode	
Transfer time	0 ms	
Protections	Short-circuit, overload, overtemperature, battery low voltage, overvoltage, undervoltage and fan failure	
Max. number of parallel connections	4	
Communications	RS232 (standard), USB / RS485 / dry contacts / SNMP / battery temperature compensation (optional)	
Display	LCD + LED	
OTHERS		
Operating temperature	0°C ~ 40°C	
Storage temperature	-25°C ~ 55°C (without battery)	
Relative humidity	0 ~ 95% (non-condensing)	
Altitude	≤ 1000 m, derating 1% for each additional 100 m	
IP rating	IP 20	
Noise level at 1 m	≤ 55 dB	≤ 58 dB
Dimensions (W × D × H) (mm)	440 × 660 × 176 (S) 440 × 580 × 88 (H)	
Packaged dimensions (W × D × H) (mm)	554 × 792 × 418 (S) 514 × 696 × 168 (H)	
Net weight (kg)	58 (S), 12 (H)	63 (S), 14 (H)
Gross weight (kg)	68 (S), 14 (H)	73 (S), 16 (H)

• S means standard model; H means long time model.
• All specifications are subject to change without notice.

EA900 G4

10 kVA ~ 20 kVA
(3:1 / 1:1)
PF1.0



Features

- High frequency on-line double conversion technology
- Advanced DSP and 3-level technology
- Output power factor 1.0
- Active power factor correction (APFC), input power factor up to 0.99
- High efficiency 95% (up to 98% in ECO mode)
- Advanced digital parallel technology
- 3:1 to 1:1 model settable
- Wide input voltage range (190 ~ 499 Vac) and frequency range (40 ~ 70 Hz)
- 50 / 60 Hz frequency auto sensing
- Two modes of frequency conversion: 50 Hz input / 60 Hz output or 60 Hz input / 50 Hz output
- Dual-input design, supporting independent bypass
- Flexible battery configuration (settable 16 - 20 pcs batteries)
- Digitally controlled charger
- High charging current available (Max. 10 A)
- Charging voltage and current configured by demands
- Linear derating in low voltage input reducing battery discharging times, extending the service life of battery

- Intelligent battery management, automatic floating / equalizing charge control, charger dormancy control, increasing battery life by 50%
- Ability to switch on the UPS with batteries
- Fan speed varies intelligently with temperature, reducing noise and extending its service life
- Equipped with self-aging function
- Compact internal layout, miniaturized the complete unit for small footprint
- LCD+LED display, multi-functional keys operation, friendly human-machine interface
- Powerful background software for parameters configuration
- Advanced multi-platform communications: RS232, USB, RS485, SNMP and dry contacts communication interfaces
- Effective software and hardware protection function, robust self-diagnostic function, and abundant event logs for check

Available Options

- RS232 and smart card slot included
- Optional parallel function, battery temperature compensation, SNMP card, USB, RS485 card, dry contacts, EMD and SMS alarms

Rear Panel

1. RS232
2. EPO
3. Parallel Port (optional)
4. USB (optional)
5. Temperature Detection (optional)
6. Intelligent Slot
7. Reserved: for manual bypass or battery breaker or outlets etc.
8. Fans
9. Bypass Breaker
10. Input Breaker
11. GND
12. Terminals and Cover



10 kVA (H)

15/20 kVA (H)

10 kVA (S)

Specifications

MODEL	EA9010 (3:1)	EA9015 (3:1)	EA9020 (3:1)
Capacity	10 kVA / 10 kW	15 kVA / 15 kW	20 kVA / 20 kW
INPUT			
Input wiring	Three-phase five-wire (3Φ + N + PE)		
Rated voltage	380 / 400 / 415 Vac		
Voltage range	190 ~ 305 Vac (linear derating between 50% and 100% load); 305 ~ 499 Vac (no derating)		
Rated frequency	50 / 60 Hz (auto-sensing)		
Frequency range	40 ~ 70 Hz		
Power factor	≥ 0.99		
Bypass voltage range	- 40% ~ +15% (settable)		
Total harmonic distortion (THDi)	≤ 5%		
OUTPUT			
Output wiring	Single-phase three-wire (1Φ + N + PE)		
Rated voltage	208 (PF=0.9) / 220 / 230 / 240 Vac		
Voltage regulation	± 1%		
Frequency	Synchronized to bypass in mains mode; 50 / 60 Hz ± 0.1 Hz in battery mode		
Waveform	Sinusoidal		
Power factor	1		
Total harmonic distortion (THDv)	≤ 1% (linear load); ≤ 3% (non-linear load)		
Crest factor	3:1		
Overload	105% ~ 110% for 10 min, 110% ~ 125% for 1 min, 126% ~ 150% for 30 s		
BATTERIES			
DC voltage	192 Vdc (192 ~ 240 Vdc settable)		
Number of battery	16 pcs (16 ~ 20 settable)		
Inbuilt battery (standard model)	12 V / 9 Ah×16	/	/
Charging current	Standard model: 1 A; Long time model: 5 A (default), 1 ~ 5 A settable; 10 A (optional)		
Recharge time	Standard model: 90% capacity restored in 8 hours; Long time model: depend on the capacity of battery		
SYSTEM			
Efficiency	≥ 94% at 100% load, max. 95% at 60% load, ≥ 98% in ECO mode		
Transfer time	0 ms		
Protections	Short-circuit, overload, overtemperature, battery low voltage, overvoltage, undervoltage and fan failure		
Max. number of parallel connections	4		
Communications	RS232 (standard), USB / RS485 / dry contacts / SNMP / battery temperature compensation (optional)		
Display	LCD + LED		
OTHERS			
Operating temperature	0°C ~ 40°C		
Storage temperature	-25°C ~ 55°C (without battery)		
Relative humidity	0 ~ 95% (non-condensing)		
Altitude	≤ 1000 m, derating 1% for each additional 100 m		
IP rating	IP 20		
Noise level at 1 m	≤ 58 dB		
Dimensions (W × D × H) (mm)	191 × 495 × 711 (S) 191 × 495 × 350 (H)	191 × 495 × 515 (H)	
Packaged dimensions (W × D × H) (mm)	310 × 685 × 941 (S) 318 × 617 × 475 (H)	285 × 593 × 618 (H)	
Net weight (kg)	64 (S), 18.5 (H)	26.5 (H)	
Gross weight (kg)	72 (S), 20 (H)	28 (H)	

- S means standard model; H means long time model.
- All specifications are subject to change without notice.

EA900RT G4

10 kVA ~ 20 kVA
(3:1 / 1:1)
PF 1.0



Features

- High frequency on-line double conversion technology
- Advanced DSP and 3-level technology
- Output power factor 1.0
- Active power factor correction (APFC), input power factor up to 0.99
- High efficiency 95% (up to 98% in ECO mode)
- Advanced digital parallel technology
- 3:1 to 1:1 model settable
- Wide input voltage range (190 ~ 478 Vac) and frequency range (40 ~ 70 Hz)
- 50 / 60 Hz frequency auto sensing
- Two modes of frequency conversion: 50 Hz input / 60 Hz output or 60 Hz input / 50 Hz output
- Dual-input design, supporting independent bypass
- Hot-swappable battery (10 kVA)
- Flexible battery configuration (settable 16 - 20 pcs batteries)
- Digitally controlled charger
- High charging current available (Max. 10 A)
- Charging voltage and current configured by demands
- Linear derating in low voltage input reducing battery discharging times, extending the service life of battery
- Intelligent battery management, automatic floating/equalizing charge control, charger dormancy control, increasing battery life by 50%
- Ability to switch on the UPS with batteries
- Settable delayed start time when mains power is restored, reducing the impact on power grid or generator
- Fan speed varies intelligently with temperature, reducing noise and extending its service life
- Equipped with self-aging function
- Compact internal layout, miniaturized the complete unit for small footprint
- LCD+LED display, multi-functional keys operation, friendly human-machine interface
- Powerful background software for parameters configuration
- Advanced multi-platform communications: RS232, USB, RS485, SNMP and dry contacts communication interfaces
- Effective software and hardware protection function, robust self-diagnostic function, and abundant event logs for check

Available Options

- RS232 and smart card slot included
- Optional parallel function, battery temperature compensation, SNMP card, USB, RS485 card, dry contacts, EMD, and SMS alarms

Rear Panel

1. SNMP (optional)
2. Fans
3. Parallel Port (optional)
4. RS232
5. EPO
6. USB (optional)
7. Temperature Compensation (optional)
8. GND
9. Bypass Breaker
10. Terminal and Cover

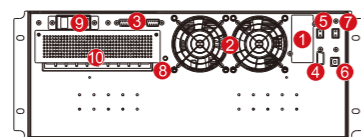

10 kVA (S) (3:1)

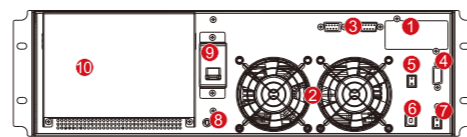

15/20 kVA (H) (3:1)



10 kVA (H) (3:1)

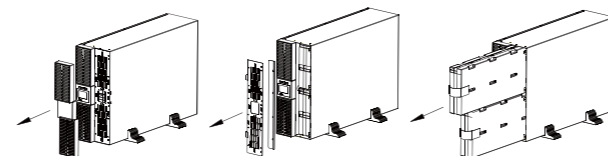

Easy for maintenance, hot-swappable battery(10 kVA)

Specifications

MODEL	EA9010RT (3:1)	EA9015RT (3:1)	EA9020RT (3:1)
Capacity	10 kVA / 10 kW	15 kVA / 15 kW	20 kVA / 20 kW
INPUT			
Input wiring	Three-phase five-wire (3Φ + N + PE)		
Rated voltage	380 / 400 / 415 Vac		
Voltage range	190 ~ 304 Vac (linear derating between 50% and 100% load); 304 ~ 478 Vac (no derating)		
Rated frequency	50 / 60 Hz (auto-sensing)		
Frequency range	40 ~ 70 Hz		
Power factor	≥ 0.99		
Bypass voltage range	- 40% ~ +15% (settable)		
Total harmonic distortion (THDi)	≤ 5%		
OUTPUT			
Output wiring	Single-phase (L-N)		
Rated voltage	208 (PF=0.9) / 220 / 230 / 240 Vac		
Voltage regulation	± 1%		
Frequency	Synchronized to bypass in mains mode; 50 / 60 Hz ± 0.1 Hz in battery mode		
Waveform	Sinusoidal		
Power factor	1		
Total harmonic distortion (THDv)	≤ 1% (linear load); ≤ 3% (non-linear load)		
Crest factor	3:1		
Overload	105% ~ 110% for 10 min, 110% ~ 125% for 1 min, 126% ~ 150% for 30 s		
BATTERIES			
DC voltage	192 Vdc (192 ~ 240 Vdc settable)		
Number of battery	16 pcs (16 ~ 20 settable)		
Inbuilt battery (standard model)	12 V / 9 Ah × 16	/	/
Charging current	Standard model: 1 A; Long time model: 5 A (default), 1 ~ 5 A settable; 10 A (optional)		
Recharge time	Standard model: 90% capacity restored in 8 hours; Long time model: depend on the capacity of battery		
SYSTEM			
Efficiency	≥ 94% at 100% load, max. 95% at 60% load, ≥ 98% in ECO mode		
Transfer time	0 ms		
Protections	Short-circuit, overload, overtemperature, battery low voltage, overvoltage, undervoltage and fan failure		
Max. number of parallel connections	4		
Communications	RS232 (standard), USB / RS485 / dry contacts / SNMP / battery temperature compensation (optional)		
Display	LCD + LED		
OTHERS			
Operating temperature	0°C ~ 40°C		
Storage temperature	-25°C ~ 55°C (without battery)		
Relative humidity	0 ~ 95% (non-condensing)		
Altitude	≤ 1000 m, derating 1% for each additional 100 m		
IP rating	IP 20		
Noise level at 1 m	≤ 58 dB		
Dimensions (W × D × H) (mm)	440 × 660 × 176 (S) 440 × 650 × 88 (H)	440 × 780 × 132	
Packaged dimensions (W × D × H) (mm)	554 × 792 × 418 (S) 514 × 696 × 168 (H)	554 × 792 × 400	
Net weight (kg)	67 (S), 17 (H)	25.5	
Gross weight (kg)	77 (S), 19 (H)	28	

- S means standard model; H means long time model.
- All specifications are subject to change without notice.

EA990 G5

10 kVA ~ 60 kVA
(3:3)
PF 1.0



Features

- High frequency on-line double conversion technology
- Advanced dual-core DSP control technology and 3-level technology
- Active power factor correction (APFC), input power factor up to 0.99
- System efficiency is improved to 96%, energy saving rate is doubled
- Output power factor 1.0
- Dual input design, supporting independent bypass
- Advanced digital and parallel technology, providing higher reliability than single system
- Wide input voltage range
- 50 / 60 Hz auto-sensing frequency
- 50 / 60 Hz frequency conversion mode
- Work efficiency up to 98% in ECO mode
- Fan speed varies intelligently with load, reducing noise and extending its service life
- Conformal coating technology to make UPS operate in harsh environment for a long time
- Flexible battery configuration setting, selectable battery numbers: 32~ 40 pcs
- Digitally controlled charger
- Ability to switch on the UPS by battery in the absence of mains power (Cold start)
- Zero switching time for UPS power supply mode when the mains power is unstable, ensuring the output is uninterrupted
- Compact internal layout, small footprint
- 5 inches LCD colorful touch screen, friendly human & machine interface
- Powerful background software for parameters configuration and online upgrade
- Advanced multi-platform communication for UPS monitoring: RS232, USB, RS485, dry contacts, SNMP card, Wi-Fi card and GPRS card
- Linear derating in low voltage input, reducing battery discharging times, extending the service life of battery
- Intelligent battery management, automatic equalized and float charging control, charger dormancy control, improving the reliability of charger and extending the battery life
- Effective hardware and software protection, robust self-diagnosis function, abundant event logs for future check
- Standard RS232, USB, RS485, EPO, Dry contacts, Parallel port
- Optional SNMP card, WI-FI card, GPRS card, SMS alarms

Specifications

MODEL	EA9910	EA9915	EA9920	EA9930	EA9940	EA9960
Power rating	10kVA/10kW	15kVA/15kW	20kVA/20kW	30kVA/30kW	40kVA/40kW	60kVA/60kW
INPUT						
Phase	3:3 / 3:1 / 1:1					
Rated voltage	220/230/240Vac (L-N) 380/400/415Vac (3Φ + N + PE)					
Voltage range	132~275Vac (L-N) 228~478Vac					
Rated frequency	50 / 60 Hz					
Frequency range	40 ~ 70 Hz					
Power factor	> 0.99					
Bypass voltage range	Selectable, default -20%~+15% Up limited: +10%, +15%, +20%, +25%; Down limited: -10%, -15%, -20%, -30%, -40%					
Bypass frequency range	Selectable, ±1Hz, ±3Hz, ±5Hz					
Input current THDi	<3% (linear load)					
Bypass overload	125%: long term operation; 125%~130%: 10min; 130%~150%: 1min; 150%~400%: 1s; >400%, less than 200ms					
OUTPUT						
Rated voltage	220/230/240Vac (L-N) 380/400/415Vac (3Φ + N + PE)					
Voltage precision	±1% (linear load)					
Frequency	Synchronized with utility in mains mode, 50/60 Hz ± 0.1 Hz in battery mode					
Waveform	Sinusoidal					
Power factor	1					
Total harmonic distortion (THDv)	<1% (full linear load); <3% (full non-linear load according to IEC/EN62040-3)					
Crest factor	3:1					
Overload	<110%, 60min; 110%~125%, 10min; 125%~150%, 1min; >150%, 200ms					
BATTERIES						
DC voltage	Long time model: ±240VDC (selectable, 32 - 40pcs)					
Standard model battery voltage	(10+10) x 9AH	(20+20) x 7AH	(20+20) x 9AH	(15+15) x 9AH x 2 strings	(20+20) x 9AH x 2 strings	/
Charging current	10A Max.				15A Max.	20A Max.
Charger voltage precision	1%					
SYSTEM						
Display	5 inches touch screen					
Efficiency	95% Max.				96% Max.	
Transfer time	0 ms					
Interface	Standard: RS232, RS485, USB, battery cold start Option: programmable dry contact, SNMP, parallel kit					
ENVIRONMENT						
Operating temperature	0°C ~ 40°C					
Storage temperature	-40°C ~ 70°C					
Relative humidity	0 ~ 95% (non-condensing)					
Altitude	<1000m, load derated 1% per 100m from 1000 ~ 2000m					
Noise level at 1 m	58dB Max.			62dB Max.		
OTHERS						
Dimensions (W × D × H) (mm)	250 x 720 x 560 (S) 250 x 720 x 560 (H)	250 x 800 x 700 (S) 250 x 720 x 560 (H)	250 x 840 x 930 (S) 250 x 840 x 650 (H)	350 x 800 x 1280(S) 250 x 720 x 560 (H)	350 x 800 x 1400 (S) 350 x 800 x 718 (H)	250 x 790 x 560 (H)
Packaged dimensions (W × D × H) (mm)	350 x 800 x 722 (S) 350 x 800 x 718 (H)	350 x 900 x 862 (S) 350 x 800 x 718 (H)	350 x 950 x 1102 (S) 350 x 980 x 810 (H)	450 x 900 x 1400 (S) 350 x 800 x 718 (H)	350 x 850 x 818 (H)	
Net weight (kg)	82 (S) 31 (H)	131 (S) 33 (H)	145 (S) 33 (H)	215 (S) 42 (H)	300 (S) 42 (H)	48 (H)
Gross weight (kg)	93 (S) 40 (H)	142 (S) 42 (H)	156 (S) 42 (H)	227 (S) 52 (H)	310 (S) 52 (H)	58 (H)

- S means standard model, H means long time model.
- Derate capacity to 90% when the number of batteries is set to 32 pcs for 40kVA/60kVA model.

- Custom-made specifications are acceptable.
- All specifications are subject to change without notice.
- Derate capacity to 60% when used at 3:1.

EA990 G5

80 kVA ~ 200 kVA
(3:3)
PF 1.0



Application

- IDC data exchange room
- ISP, computer room
- Bank/bond clearing center
- Industrial process control applications
- Precision instruments and equipment

Features

- High frequency on-line double conversion technology
- Advanced dual-core DSP control technology and 3-level technology
- Active Power Factor Correction Technology, input power factor up to 0.99
- System efficiency improved to 96%, energy saving rate is doubled
- Output power factor 1.0
- Dual input design, supporting independent bypass
- Advanced digital and parallel technology, providing higher reliability than single system
- Wide input voltage range
- 50 Hz / 60 Hz auto-sensing frequency
- 50 Hz / 60 Hz frequency conversion mode
- Working efficiency up to 98.5% in ECO mode
- Fan speed varies intelligently with load, reducing noise and extending its service life
- Conformal coating technology to make UPS operate in harsh environment for a long time
- Flexible battery configuration setting, selectable battery number: 32~40 pcs
- Digitally controlled charger (Max.60 A)
- Ability to switch on the UPS by battery in the absence of mains power (Cold start)
- Zero switching time for UPS power supply mode when the mains power is unstable, ensuring the output is uninterrupted
- Selectable size LCD colorful touch screen (5 inches and 7 inches), friendly human & machine interface
- Powerful background software for parameters configuration and online upgrade
- Advanced multi-platform communication for UPS monitoring: RS232, USB, RS485, dry contacts, SNMP card, Wi-Fi card and GPRS card
- Linear derating in low voltage input, reducing battery discharging times, extending the service life of battery.
- Intelligent battery management, automatic equalized and float charging control, charger dormancy control, improving the reliability of charger and extending the battery life
- Effective hardware and software protection, robust self-diagnosis function, abundant event log for future check
- Standard RS232, USB, RS485, EPO, dry contacts, parallel port
- Optional SNMP card, Wi-Fi card, GPRS card and SMS alarms
- Automatic dust removal function, reduce the risk of PCB corrosion

Specifications

MODEL	EA9980	EA99100	EA99120	EA99160	EA99200
Power rating	80kVA/80kW	100kVA/100kW	120kVA/120kW	160kVA/160kW	200kVA/200kW
INPUT					
Rated voltage	380 / 400 / 415 Vac (3Φ + N + PE)				
Voltage range	304~478Vac, full load 228V~304Vac, load decrease linearly according to the min phase voltage				
Rated frequency	50 / 60 Hz				
Frequency range	40~70 Hz				
Power factor	> 0.99				
Bypass voltage range	Selectable, default -20%~+15% Up limited: +10%, +15%, +20%, +25%; Down limited: -10%, -15%, -20%, -30%, -40%				
Bypass frequency range	Selectable, ±1Hz, ±3Hz, ±5Hz				
Input current THDi	<3% (linear load)				
Bypass overload	125%: long term operation; 125%~130%: 10min; 130%~150%: 1min; 150%~400%: 1s; >400%, less than 200ms				
OUTPUT					
Rated voltage	380 / 400 / 415 Vac (3Φ + N + PE)				
Voltage precision	±1% (linear load)				
Frequency	Synchronized with utility in mains mode, 50/60 Hz ± 0.1 Hz in battery mode				
Waveform	Sinusoidal				
Power factor	1				
Total harmonic distortion (THDv)	<1% (full linear load); <3% (full non-linear load according to IEC/EN62040-3)				
Crest factor	3:1				
Overload	<110%, 60min; 110%~125%, 10min; 125%~150%, 1min; >150%, 200ms				
BATTERIES					
Long run model battery voltage	±240VDC(Selectable,32~50pcs)				
Charging current	30 A	40 A		60 A	
Charger voltage precision	<1%				
SYSTEM					
Display	Default : 5 inch touch screen			Default : 7 inch touch screen	
Efficiency	96%				
Transfer time	0 ms				
Interface	Standard: RS232, RS485, USB, battery cold start Option: programmable dry contact, SNMP, parallel kit				
ENVIRONMENT					
Operating temperature	0°C ~ 40°C				
Storage temperature	-40°C ~ 70°C				
Relative humidity	0 ~ 95% (non-condensing)				
Noise level at 1 m	< 70dB				
Altitude	<1000 m, load derated 1% per 100 m from 1000 ~ 2000m				
OTHERS					
Dimensions (W × D × H) (mm)	360 x 800 x 1200	360 x 850 x 1200		440 x 850 x 1250	
Packaged dimensions (W × D × H) (mm)	450 x 870 x 1350	450 x 940 x 1350		530 x 940 x 1410	
Net weight (kg)	152	156	160	194	200
Gross weight (kg)	172	180	180	214	220

EA990RT G5

10 kVA ~ 60 kVA
(3:3)
PF 1.0



Features

- High frequency on-line double conversion technology
- Advanced dual-core DSP control technology and 3-level technology
- Active power factor correction (APFC), input power factor up to 0.99
- System efficiency is improved to 96%, energy saving rate is doubled
- Output power factor 1.0
- Dual input design, supporting independent bypass
- Advanced digital and parallel technology, providing higher reliability than single system
- Wide input voltage range
- 50 / 60 Hz auto-sensing frequency
- 50 / 60 Hz frequency conversion mode
- Work efficiency up to 98% in ECO mode
- Fan speed varies intelligently with load, reducing noise and extending its service life
- Conformal coating technology to make UPS operate in harsh environment for a long time
- Flexible battery configuration setting, selectable battery numbers: 32~ 40 pcs
- Digitally controlled charger (Max.20 A)
- Ability to switch on the UPS by battery in the absence of mains power (Cold start)
- Zero switching time for UPS power supply mode when the mains power is unstable, ensuring the output is uninterrupted
- Compact internal layout, small footprint
- 5 inches LCD colorful touch screen, friendly human & machine interface
- Powerful background software for parameters configuration and online upgrade
- Advanced multi-platform communication for UPS monitoring: RS232, USB, RS485, dry contacts, SNMP card, Wi-Fi card and GPRS card
- Linear derating in low voltage input, reducing battery discharging times, extending the service life of battery
- Intelligent battery management, automatic equalized and float charging control, charger dormancy control, improving the reliability of charger and extending the battery life
- Effective hardware and software protection, robust self-diagnosis function, abundant event logs for future check
- Standard RS232, USB, RS485, EPO, Dry contacts, Parallel port
- Optional SNMP card, WI-FI card, GPRS card, SMS alarms

Rear Panel

1. The touch screen LCD
2. LED
3. Battery start button
4. SNMP card (optional)
5. Dry contacts
6. Parallel port
7. RS232
8. RS485
9. USB
10. EPO
11. Terminal block
12. GND
13. Battery connectors for 30kVA

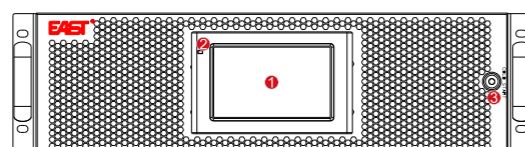

10-60kVA front appearance

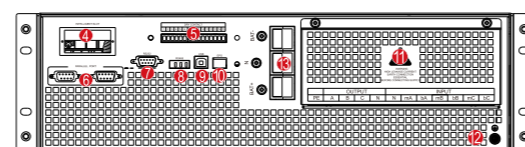

30kVA back appearance

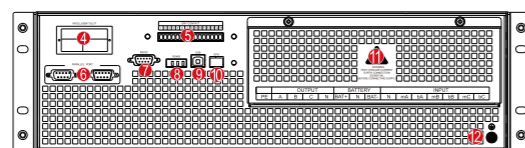

10-20kVA back appearance

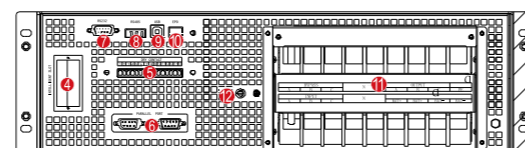

40-60kVA back appearance

Specifications

MODEL	EA9910RT	EA9915RT	EA9920RT	EA9930RT	EA9940RT	EA9960RT
Capacity	10 kVA / 10 kW	15 kVA / 15 kW	20 kVA / 20 kW	30 kVA / 30 kW	40 kVA / 40 kW	60 kVA / 60 kW
INPUT						
Rated voltage	380 / 400 / 415 Vac (3Φ + N + PE)					
Voltage range	304~478 Vac, full load 228V~304 Vac, load decrease linearly according to the min phase voltage					
Rated frequency	50 / 60 Hz (auto-sensing)					
Frequency range	40 ~ 70 Hz					
Power factor	> 0.99					
Bypass voltage range	Selectable, default ~ 20% ~ +15% Up limited: +10%, +15%, +20%, +25%; Down limited: -10%, -15%, -20%, -30%, -40%					
Bypass frequency range	Selectable, ±1Hz, ±3Hz, ±5Hz					
Total harmonic distortion (THDi)	<3% (full linear load)					
Bypass overload	125%: long term operation; 125%~130%: 10min; 130%~150%: 1min; 150%~400%: 1s; >400%, less than 200ms					
OUTPUT						
Rated voltage	380 / 400 / 415 Vac (3Φ + N + PE)					
Voltage regulation	±1% (full linear load)					
Frequency	Synchronized with utility in mains mode, 50/60 Hz ± 0.1 Hz in battery mode					
Waveform	Sinusoidal					
Power factor	1					
Total harmonic distortion (THDv)	<1% (full linear load), <3% (full non-linear load according to IEC / EN62040-3)					
Crest factor	3:1					
Overload	<110%, 60min; 110%~125%, 10min; 125%~150%, 1min; >150%, 200ms					
BATTERIES						
DC voltage	±240VDC (selectable, 32 - 40pcs)					
Charging current	10A Max.			15 A		20 A
Charger voltage precision	1%					
Recharge time	Long time model: depend on the capacity of battery					
SYSTEM						
Efficiency	95% Max.			96% Max.		
Transfer time	0 ms					
Max. number of parallel connections	4					
Protections	Short-circuit, overload, overtemperature, battery low voltage, overvoltage, undervoltage and fan failure					
Communications	RS232, USB, RS485, EPO, Dry contacts, Parallel port (Standard) SNMP card, WI-FI card, GPRS card, SMS alarms (Optional)					
Display	LED + 5 inches LCD touch screen					
OTHERS						
Operating temperature	0°C ~ 40°C					
Storage temperature	-40°C ~ 70°C					
Relative humidity	0 ~ 95% (Non-condensing)					
Altitude	<1000m, load derated 1% per 100m from 1000 ~ 2000m					
IP rating	IP 20					
Noise level at 1 m	<60dB			<65dB		
Dimensions (W × D × H) (mm)	440 x 660 x 130		440 x 750 x 130	440 x 730 x 130	440 x 800 x 130	
Packaged dimensions (W × D × H) (mm)	532 x 800 x 204		532 x 890 x 204	535 x 865 x 226	535 x 930 x 226	
Net weight (kg)	22	24	29	33	39	
Gross weight (kg)	24	26	31	36	42	

- S means standard model, H means long time model.
- All specifications are subject to change without notice.

• Custom-made specifications are acceptable.

EA990 G4

40 kVA ~ 200 kVA
(3:3)
PF 1.0



Features

- High frequency on-line double conversion technology
- Advanced dual-core DSP control technology and 3-level technology
- Output power factor 1.0
- Active Power Factor Correction Technology, input power factor up to 0.99
- System efficiency improved to 96%, energy saving rate is doubled
- Working efficiency up to 99% in ECO mode
- Dual input design, supporting independent bypass
- Advanced digital and parallel technology, providing higher reliability than single system
- Wide input voltage range, 50 / 60 Hz auto-sensing frequency
- 50 Hz / 60 Hz frequency conversion mode
- Compact internal layout, small footprint
- Fan speed varies intelligently with temperature, reducing noise and extending its service life
- Features strong fault tolerance, one fan damaged takes 50% of the load, two fans damaged take 30% of the load
- Conformal coating technology to make UPS operate in harsh environment for a long time
- Effective hardware and software protection, robust self-diagnosis function, abundant event logs for future check
- Linear downgrading in low voltage input reducing battery discharging times
- Flexible battery configuration setting, selectable battery numbers: 30 ~ 44 pcs
- Digitally controlled charger (Max. 48 A)
- Ability to switch on the UPS by battery in the absence of mains power (Cold start)
- Zero switching time for UPS power supply mode when the mains power is unstable, ensuring output uninterrupted
- Settable delayed start time when mains power is restored
- 5 inches LCD colorful touch screen, friendly human & machine interface
- Powerful background software for parameters configuration and online upgrade
- Advanced multi-platform communication for UPS monitoring: RS232, USB, RS485, RJ45, dry contacts, SNMP card, Wi-Fi card and GPRS card
- Intelligent battery management, automatic equalized and float charging control, charger dormancy control, improving the reliability of charger and extending the battery life
- Options and accessories: RS232, USB, RS485, RJ45, parallel, dry contacts, EPO and battery temperature compensation interfaces supplied; optional SNMP card, Wi-Fi card, GPRS card, battery temperature sensor, EMD detector and SMS alarms

Specifications

MODEL	EA9940	EA9960	EA9980	EA99100	EA99120	EA99160	EA99200
Capacity	40 kVA/40 kW	60 kVA/60 kW	80 kVA/80 kW	100 kVA/100 kW	120 kVA/120 kW	160 kVA/160 kW	200 kVA/200 kW
INPUT							
Input wiring	Three-phase five-wire (3Φ + N + PE)						
Rated voltage	380 / 400 / 415 Vac						
Voltage range	304 ~ 485 Vac (no downgrading), 138 ~ 304 Vac (linear downgrading between 40% ~ 100% load)						
Rated frequency	50 / 60 Hz (auto-sensing)						
Frequency range	40 ~ 70 Hz						
Power factor	≥ 0.99						
Bypass voltage range	-60% ~ +20% (settable)						
Total harmonic distortion (THDi)	≤ 3%						
OUTPUT							
Output wiring	Three-phase five-wire (3Φ + N + PE)						
Rated voltage	380 / 400 / 415 Vac						
Voltage regulation	± 1%						
Frequency	Synchronized with utility in mains mode, 50 / 60 Hz ± 0.1% in battery mode						
Waveform	Sinusoidal						
Power factor	1						
Total harmonic distortion (THDv)	≤ 1% (linear load); ≤ 4% (non-linear load)						
Crest factor	3:1						
Overload	105% ~ 110% for 60 min, 110% ~ 125% for 10 min, 125% ~ 150% for 1 min, >150% for 0.2 s						
BATTERIES							
DC voltage	± 192 Vdc (± 180 ~ ± 264 Vdc settable) 40 kVA built-in battery: ± 240 Vdc (80 pcs 9 Ah/12 V)						
Number of battery	32 pcs (30 ~ 44 pcs settable)						
Charging current (max.)	12 A	24 A		36 A		48 A	
Recharge time	Depend on the capacity of battery						
SYSTEM							
Efficiency	Max. 96% in online mode, 99% in ECO mode						
Transfer time	0 ms						
Protections	Short-circuit, overload, overtemperature, excessive low battery, overvoltage, undervoltage, fans failure						
Max. number of parallel connections	4						
Communications	Standard configuration: RS232, USB, RS485, RJ45, dry contacts; Optional configuration: SNMP card, Wi-Fi card, GPRS card						
Display	5 inches colorful LCD touch screen						
OTHERS							
Operating temperature	0°C~40°C						
Storage temperature	-25°C~55°C (without battery)						
Relative humidity	0% ~ 95% (non-condensing)						
Altitude	≤ 1000 m; above 1000 m, downgrading 1% for each additional 100 m						
IP rating	IP 20						
Noise level at 1 m	≤ 65 dB						
Dimensions (W × D × H) (mm)	360 × 850 × 885	360 × 850 × 950	360 × 850 × 1200	440 × 850 × 1200		600 × 850 × 1200	
Packaged dimensions (W × D × H) (mm)	450 × 940 × 1055	450 × 940 × 1120	450 × 940 × 1370	530 × 940 × 1370		700 × 950 × 1370	
Net weight (kg)	95, 295 (built-in BAT)	130	156	158	198	250	300
Gross weight (kg)	110, 310 (built-in BAT)	145	172	180	220	275	325

- All specifications are subject to change without notice.
- Custom-made specifications are acceptable.
- Derate capacity to 90% when the number of batteries is set to 30 pcs.